

CATÁLOGO DE PRODUTOS



MACCHINA PRO

LINHAS HIDRÁULICAS
E PNEUMÁTICAS



LINHAS HIDRÁULICAS



CATÁLOGO DE PRODUTOS

Mangueiras de baixa pressão para ar-comprimido, fabricadas em borracha sintética, com reforço interno com 1 trama têxtil (1000 - 1620 PSI) : SAE J517 100r6 / EN 854 1TE

exceeds SAE J517 100 R6 - EN 854 1TE

Tube: oil resistant synthetic rubber.

Reinforcement: one high tensile textile braid.

Cover: abrasion, ozone and hydrocarbon resistant synthetic rubber.

Application: low pressure hydraulic lines, fuel oil, antifreeze solutions, air and water.

Temperature: -40 °C +100 °C (-40 °F +212 °F)
air max T = +70 °C (+160 °F)

Length: random



Item Code	ID (Dash)	ID (mm)	ID (in)	OD (mm)	OD (in)	WP (Mpa)	WP (psi)	BP (Mpa)	BP (psi)	BR (mm)	BR (in)	Weight (kg/m)	Weight (lb/ft)
1001385	4	6,0	1/4"	11,9	0,47	2,8	400	11,2	1620	64	2,52	0,110	0,08
1001386	5	8,0	5/16"	13,6	0,54	2,8	400	11,2	1620	76	2,99	0,130	0,09
1001387	6	10,0	3/8"	15,0	0,59	2,8	400	11,2	1620	76	2,99	0,160	0,11
1001388	8	13,0	1/2"	18,4	0,72	2,8	400	11,2	1620	102	4,02	0,220	0,15
1001389	10	16,0	5/8"	22,5	0,89	2,4	350	9,6	1400	107	4,21	0,270	0,19
1001390	12	19,0	3/4"	26,4	1,04	2,1	300	8,4	1200	152	5,98	0,367	0,25
1001391	16	25,0	1"	33,1	1,30	1,7	250	7,0	1000	203	7,99	0,476	0,32



CATÁLOGO DE PRODUTOS

Mangueira de borracha sintética com reforço interno com 1 trama de aço (600 - 3250 PSI): SAE 100R1AT / ISO 1436-1 / UNI EN 853 1SN

SAE 100 R1AT - ISO 1436-1 - UNI EN 853 1SN

Tube: oil resistant synthetic rubber.

Reinforcement: one high tensile steel braid.

Cover: smooth up to 1", wrapped over 1". Abrasion, ozone and hydrocarbon resistant synthetic rubber.

Application: high pressure hydraulic lines, fuel oil, antifreeze solutions, air and water.

Temperature: -40 °C +100 °C (-40 °F +212 °F)
air max T = +70 °C (+160 °F)

Length: random up to 1" - 61 m max over 1 1/4"



Item Code	ID (Dash)	ID (mm)	ID (in)	OD (mm)	OD (in)	WP (Mpa)	WP (psi)	BP (Mpa)	BP (psi)	BR (mm)	BR (in)	Weight (kg/m)	Weight (lb/ft)
1002311	4	6,0	1/4"	12,7	0,50	22,5	3250	90,0	13000	100	3,94	0,192	0,13
1002312	5	8,0	5/16"	14,2	0,56	21,5	3120	86,0	12500	115	4,53	0,228	0,16
1002313	6	10,0	3/8"	16,5	0,65	18,0	2610	72,0	10500	130	5,12	0,287	0,20
1002314	8	13,0	1/2"	19,9	0,78	16,0	2320	64,0	9280	180	7,09	0,372	0,26
1002315	10	16,0	5/8"	23,0	0,91	13,0	1900	52,0	7560	200	7,87	0,420	0,29
1002316	12	19,0	3/4"	27,0	1,06	10,5	1530	42,0	6000	240	9,45	0,543	0,37
1002317	16	25,0	1"	35,0	1,38	8,8	1280	35,2	5100	300	11,81	0,864	0,59
1002497	20	32,0	1 1/4"	42,1	1,66	6,3	920	25,2	3680	420	16,54	1,042	0,71
1002319	24	38,0	1 1/2"	49,2	1,94	5,0	730	20,0	2900	500	19,69	1,330	0,90
1002321	32	51,0	2"	62,4	2,46	4,0	600	16,0	2320	630	24,80	1,835	1,24



CATÁLOGO DE PRODUTOS

Mangueira de borracha sintética com reforço interno com 2 tramas de aço (1200 - 6000 PSI):
SAE 100R2AT / ISO 1436-1 / UNI EN 853 2SN

SAE 100 R2AT - ISO 1436-1 - UNI EN 853 2SN

Tube: oil resistant synthetic rubber.

Reinforcement: two high tensile steel braids.

Cover: smooth up to 1", wrapped over 1". Abrasion, ozone and hydrocarbon resistant synthetic rubber.

Application: high pressure hydraulic lines, fuel oil, antifreeze solutions, air and water.

Temperature: -40 °C +100 °C (-40 °F +212 °F)

air max T = +70 °C (+160 °F)

Length: random up to 1" - 61 m max over 1 1/4"



Item Code	ID (Dash)	ID (mm)	ID (in)	OD (mm)	OD (in)	WP (Mpa)	WP (psi)	BP (Mpa)	BP (psi)	BR (mm)	BR (in)	Weight (kg/m)	Weight (lb/ft)
1001341	3	5,0	3/16"	13,0	0,51	42,0	6000	168,0	24000	90	3,54	0,282	0,19
1001342	4	6,0	1/4"	14,2	0,56	40,0	5850	160,0	23200	100	3,94	0,330	0,23
1001343	5	8,0	5/16"	15,8	0,62	35,0	5000	140,0	20000	115	4,53	0,357	0,24
1001344	6	10,0	3/8"	18,2	0,72	33,0	4800	132,0	19200	125	4,92	0,460	0,31
1001345	8	13,0	1/2"	21,3	0,84	27,5	4000	110,0	16000	175	6,89	0,534	0,36
1001346	10	16,0	5/8"	24,5	0,96	25,0	3630	100,0	14500	200	7,87	0,670	0,46
1001347	12	19,0	3/4"	28,6	1,13	21,5	3120	86,0	12500	240	9,45	0,895	0,61
1001348	16	25,0	1"	36,6	1,44	16,5	2400	66,0	9500	300	11,81	1,250	0,85
1001349	20	32,0	1 1/4"	46,4	1,83	12,5	1820	50,0	7280	420	16,54	1,852	1,25
1001350	24	38,0	1 1/2"	52,8	2,08	9,0	1310	36,0	5240	500	19,69	2,086	1,41
1001351	32	51,0	2"	65,6	2,58	8,0	1200	32,0	4640	630	24,80	2,748	1,85



CATÁLOGO DE PRODUTOS

Mangueira de borracha sintética, com reforço de 1 trama têxtil e 1 espiral de aço para retorno de óleo (30- 300 PSI): SAE 100R4

SAE 100 R4

Tube: oil resistant synthetic rubber.

Reinforcement: high tensile textile cords with embedded steel helix wire.

Cover: abrasion, ozone and hydrocarbon resistant synthetic rubber.

Application: fuel, oil and hydraulic fluids with 50% max aromatic content suction and delivery.

Specially designed for hydraulic oil return lines.

Temperature: -40 °C +100 °C (-40 °F +212 °F)

Length: 61 m max

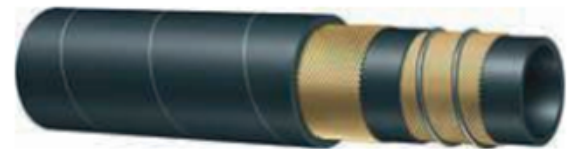

Item Code	ID (Dash)	ID (mm)	ID (in)	OD (mm)	OD (in)	WP (Mpa)	WP (psi)	BP (Mpa)	BP (psi)	BR (mm)	BR (in)	Weight (kg/m)	Weight (lb/ft)
1001123	12	19,0	3/4"	30,0	1,18	2,1	300	8,4	1200	57	2,24	0,610	0,41
1001124	16	25,0	1"	36,0	1,42	1,7	250	6,8	986	75	2,95	0,760	0,52
1001126	20	32,0	1 1/4"	43,0	1,69	1,4	200	5,6	800	96	3,78	0,990	0,67
1001127	24	38,0	1 1/2"	49,0	1,93	1,0	150	4,2	620	114	4,49	1,140	0,77
1001128	32	51,0	2"	62,0	2,44	0,7	100	2,8	400	152	5,98	1,480	1,00
1001129	40	63,0	2 1/2"	76,0	2,99	0,4	60	1,6	240	189	7,44	2,100	1,42
1001130	48	76,0	3"	89,0	3,50	0,4	60	1,6	240	228	8,98	2,520	1,70
1001131	56	90,0	3 1/2"	104,0	4,09	0,3	45	1,2	180	270	10,63	3,080	2,07
1001132	64	102,0	4"	116,0	4,57	0,2	30	0,8	120	306	12,05	3,440	2,32



CATÁLOGO DE PRODUTOS

Mangueira de alta pressão para bombas/ motores hidráulicos com reforço interno em 4 espirais de aço (4000 PSI) - ISO 18752

ISO 18752

Tube: petroleum and biodegradable hydraulic fluid resistant synthetic rubber.

Reinforcement: four high tensile steel spirals.

Cover: smooth up to 1", wrapped over 1". Abrasion, ozone and hydrocarbon resistant synthetic rubber.

Application: very high pressure hydraulic lines, fuel, oil, lubricants, antifreeze solution, air and water.

Specially designed for long service life in very demanding applications where compact design, high pulsating pressure and tight bend radius are required.

Temperature: -40 °C +121 °C (-40 °F +250 °F)

Length: random up to 1" - 61 m max over 1 1/4"



Item Code	ID (Dash)	ID (mm)	ID (in)	OD (mm)	OD (in)	WP (Mpa)	WP (psi)	BP (Mpa)	BP (psi)	BR (mm)	BR (in)	Weight (kg/m)	Weight (lb/ft)
1004894	8	13,0	1/2"	22,6	0,89	28,0	4000	112,0	16000	90	3,54	0,624	0,42
1004754	12	19,0	3/4"	29,0	1,14	28,0	4000	112,0	16000	120	4,72	0,978	0,66
1004755	16	25,0	1"	37,2	1,46	28,0	4000	112,0	16000	150	5,91	1,479	1,00
1004773	20	32,0	1 1/4"	44,2	1,74	28,0	4000	112,0	16000	210	8,27	2,214	1,49
1004756	24	38,0	1 1/2"	50,6	1,99	29,0	4200	116,0	16800	250	9,84	2,610	1,76
1004757	32	51,0	2"	64,7	2,55	28,0	4000	112,0	16000	318	12,52	4,001	2,69



CATÁLOGO DE PRODUTOS

Mangueira de alta pressão para bombas/ motores hidráulicos com reforço interno em 4 ou 6 espirais de aço (4000 PSI) - ISO 18752/EXCEDE SAE 100R15

ISO 18752 - exceeds SAE 100 R15

Tube: petroleum and biodegradable hydraulic fluid resistant synthetic rubber.

Reinforcement: four/six high tensile steel spirals.

Cover: smooth up to 1", wrapped over 1". Abrasion, ozone and hydrocarbon resistant synthetic rubber.

Application: very high pressure hydraulic lines, fuel, oil, lubricants, antifreeze solution, air and water.

Specially designed for long service life in very demanding applications where compact design, high pulsating pressure and tight bend radius are required.

Temperature: -40 °C +121 °C (-40 °F +250 °F)

Length: random up to 1" - 61 m max over 1 1/4"



Item Code	Constr.	ID (Dash)	ID (mm)	ID (in)	OD (mm)	OD (in)	WP (Mpa)	WP (psi)	BP (Mpa)	BP (psi)	BR (mm)	BR (in)	Weight (kg/m)	Weight (lb/ft)
1004774	4WS	4	6,0	1/4"	17,0	0,67	45,0	6550	180,0	26200	60	2,36	0,510	0,35
1004775	4WS	6	10,0	3/8"	19,8	0,78	44,5	6450	178,0	25800	75	2,95	0,615	0,42
1004776	4WS	8	13,0	1/2"	22,5	0,89	42,0	6000	168,0	24000	90	3,54	0,710	0,48
1004777	4WS	10	16,0	5/8"	27,8	1,09	42,0	6000	168,0	24000	100	3,94	1,190	0,80
1004778	4WS	12	19,0	3/4"	30,6	1,20	42,0	6000	168,0	24000	120	4,72	1,371	0,93
1004779	4WS	16	25,0	1"	38,0	1,50	42,0	6000	168,0	24000	150	5,91	1,926	1,30
1004780	6WS	20	32,0	1 1/4"	47,6	1,87	42,0	6000	168,0	24000	225	8,86	2,982	2,01
1004781	6WS	24	38,0	1 1/2"	54,4	2,14	42,0	6000	168,0	24000	305	12,01	4,155	2,80
1004818	6WS	32	51,0	2"	68,7	2,70	42,0	6000	168,0	24000	380	14,96	6,031	4,06



CATÁLOGO DE PRODUTOS

Mangueira para alta-temperatura (600 - 3250 PSI): SAE 100R1AT / ISO 1436-1 / UNI EN853 1SN

SAE 100 R1AT - ISO 1436-1 - UNI EN 853 1SN

Tube: oil resistant synthetic rubber.

Reinforcement: one high tensile steel braid.

Cover: smooth up to 5/8", wrapped over 3/4". Abrasion, ozone and hydrocarbon resistant blue synthetic rubber.

Application: high pressure hydraulic lines, fuel oil, antifreeze solutions, air and water.

Specially designed for high temperature applications.

Not recommended for steam service.

Temperature: -40 °C +150 °C (-40 °F +300 °F)

air max T up to 5/8" = +85 °C (+185 °F),

air max T over 3/4" = +110 °C (+230 °F)

Length: random up to 5/8" - 61 m max over 3/4"

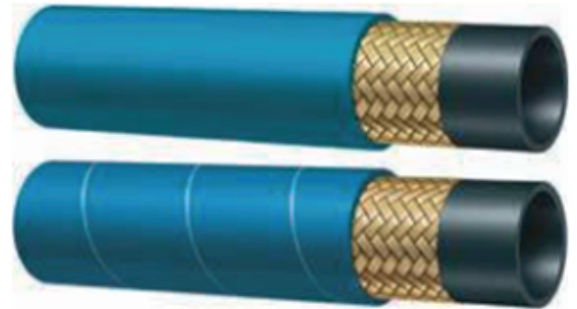

Item Code	ID (Dash)	ID (mm)	ID (in)	OD (mm)	OD (in)	WP (Mpa)	WP (psi)	BP (Mpa)	BP (psi)	BR (mm)	BR (in)	Weight (kg/m)	Weight (lb/ft)
1004518	4	6,0	1/4"	12,7	0,50	22,5	3250	90,0	13000	100	3,94	0,206	0,14
1004519	6	10,0	3/8"	16,5	0,65	18,0	2610	72,0	10500	130	5,12	0,307	0,21
1004520	8	13,0	1/2"	19,9	0,78	16,0	2320	64,0	9280	180	7,09	0,379	0,26
1004521	10	16,0	5/8"	22,7	0,89	13,0	1900	52,0	7560	200	7,87	0,436	0,30
1004522	12	19,0	3/4"	27,0	1,06	10,5	1530	42,0	6000	240	9,45	0,565	0,38
1004523	16	25,0	1"	35,8	1,41	8,8	1280	35,2	5100	300	11,81	0,976	0,66
1004530	20	32,0	1 1/4"	42,1	1,66	6,3	920	25,2	3680	420	16,54	1,121	0,76
1004531	24	38,0	1 1/2"	49,2	1,94	5,0	730	20,0	2900	500	19,69	1,443	0,97
1004532	32	51,0	2"	62,4	2,46	4,0	600	16,0	2320	630	24,80	1,911	1,29



CATÁLOGO DE PRODUTOS

Mangueiras para baixa temperatura (2000 - 6000 PSI)

Tube: oil resistant ultra low temperature synthetic rubber.
Reinforcement: two high tensile steel braids.
Cover: smooth up to 1", wrapped over 1". Oil, water, ozone and ultra low temperature resistant synthetic rubber.
Application: hydraulic system with petroleum or water/glycol based fluids, fuel, lubricating oils.
 Specially designed for ultra low temperature applications.
Temperature: -55 °C +100 °C (-67 °F +212 °F)
 air max T = +70 °C (+160 °F)
Length: random up to 1" - 61 m over 1"



Item Code	ID (Dash)	ID (mm)	ID (in)	OD (mm)	OD (in)	WP (Mpa)	WP (psi)	BP (Mpa)	BP (psi)	BR (mm)	BR (in)	Weight (kg/m)	Weight (lb/ft)
1003221	4	6,0	1/4"	13,0	0,51	42,0	6000	168,0	24000	50	1,97	0,280	0,19
1003283	5	8,0	5/16"	14,5	0,57	37,5	5500	150,0	22000	55	2,17	0,310	0,21
1003222	6	10,0	3/8"	16,8	0,66	35,0	5000	140,0	20000	65	2,56	0,390	0,27
1003226	8	13,0	1/2"	20,6	0,81	31,0	4500	124,0	18000	90	3,54	0,520	0,35
1003223	10	16,0	5/8"	23,4	0,92	28,0	4000	112,0	16000	100	3,94	0,600	0,41
1003224	12	19,0	3/4"	27,6	1,09	24,0	3500	96,0	14000	120	4,72	0,810	0,55
1003225	16	25,0	1"	35,5	1,40	21,0	3000	84,0	12000	150	5,91	1,220	0,82
1003304	20	32,0	1 1/4"	43,3	1,70	14,0	2000	58,0	8400	210	8,27	1,390	0,94



CATÁLOGO DE PRODUTOS

Mangueiras para vibradores pneumáticos de concreto (10 bar / 150 PSI):

Vibrador de concreto 10 bar (150 psi)

Tubo: SBR de cor preta

Reforço: Cordões têxteis de alta tenacidade

Cobertura: SBR de cor preta - resistente à abrasão e ao ozônio

Uso: Vibradores pneumáticos de concreto

Fator de Segurança: 4:1

Temperatura: -30 °C +80 °C (-22 °F +176 °F)



mm	inch	mm	inch	bar	psi	mm	inch	%	kg/m	lb/ft
19	3/4	31	1,22	10	150				0,690	0,465
25	1	39	1,54	10	150				1,020	0,690



CATÁLOGO DE PRODUTOS

Mangueiras para bombeamento de concreto (40 bar / 600 PSI):

Bombeamento de concreto 40 bar (600 psi)

Tubo: NR de cor preta, condutiva - resistente à abrasão

Reforço: Cordões têxteis de alta tenacidade

Cobertura: SBR/NR de cor preta, condutiva - resistente à abrasão e ao ozônio

Uso: Bombeamento de concreto

Fator de Segurança: 2,5:1

Temperatura: -30 °C +80 °C (-22 °F +176 °F)



↔		↔		⏲	↔		⌒	⌒	⌒	⌒
mm	inch	mm	inch	bar	psi	mm	inch	%	kg/m	lb/ft
51	2	69	2,72	40	600				1,840	1,240
76	3	104	4,09	40	600				4,390	2,955
90	3 1/2	118	4,65	40	600				5,150	3,465
102	4	130	5,12	40	600				5,830	3,920



CATÁLOGO DE PRODUTOS

Mangueiras para bombeamento de concreto para serviços pesados com reforço em aço (85 bar / 1275 PSI)

Bombeamento de concreto 85 bar (1275 psi)

Serviços pesados - Reforçado a aço

Tubo: NR de cor preta, condutiva - resistente à abrasão

Reforço: Cordões de aço de alta tenacidade

Cobertura: SBR/NR de cor preta, condutiva - resistente à abrasão e ao ozônio

Uso: Bombeamento de concreto a alta pressão

Fator de Segurança: 2:1

Temperatura: -30 °C +80 °C (-22 °F +176 °F)



↔		↔		⚙		⤴		⌋⌌		⚖	
mm	inch	mm	inch	bar	psi	mm	inch	%	kg/m	lb/ft	
51	2	69	2,72	85	1275	255	10,00		2,130	1,435	
63	2 1/2	85	3,35	85	1275	265	10,50		3,340	2,245	
76	3	100	3,94	85	1275	380	15,00		4,540	3,055	
90	3 1/2	116	4,57	85	1275	450	17,50		5,490	3,690	
102	4	128	5,04	85	1275	510	20,00		7,020	4,720	
127	5	155	6,10	85	1275	635	25,00		10,340	6,950	
152	6	184	7,24	85	1275	760	30,00		13,780	9,265	



CATÁLOGO DE PRODUTOS

Acoplamento para mangueiras de concreto com ponteiros pré-crimpadas (disponibilidade sob consulta):

ACOPLAMENTO PARA CONCRETO COMPLETA COM PONTEIRA PRÉ-CRIMPADA

Extremidade elevada para serviços pesados - Estilo Califórnia - Inserção endurecida

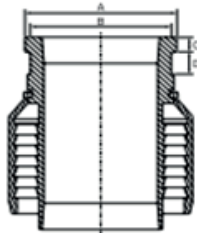

Código do Item	Número da Peça	Mangueira DI in	Mangueira DI mm	Cabeça DN in	Cabeça A mm	Cabeça B mm	Cabeça C mm	Cabeça D mm	Material
2303026	IV39JL00-051078	2	51	2	77,7	69,9	12,7	20	Aço Temperado
2303027	IV39JL00-063082	2 1/2	63	2 1/2	82,3	73,2	12,3	20	Aço Temperado
2303028	IV39JL00-076106	3	76	3	106,2	97	12,7	20	Aço Temperado
2303029	IV39JL00-102132	4	102	4	131,6	122	15,2	20	Aço Temperado
2303030	IV39JL00-127157	5	127	5	157	147,3	15,2	20	Aço Temperado

ACOPLAMENTO PARA CONCRETO COMPLETA COM PONTEIRA PRÉ-CRIMPADA

Estilo Schwing - Fêmea - Inserção endurecida

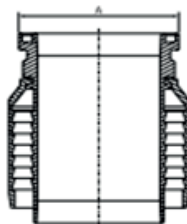

Código do Item	Número da Peça	Mangueira DI in	Mangueira DI mm	Cabeça DN in	Cabeça A mm	Material
2302894	IV39WF00-102102	4	102	4	148	Aço Temperado
2302895	IV39WF00-127127	5	127	5	166	Aço Temperado
2306524	IV39WF00-152152	6	152	6	195	Aço Temperado

ACOPLAMENTO PARA CONCRETO COMPLETA COM PONTEIRA PRÉ-CRIMPADA

Estilo Victaulic - Inserção endurecida

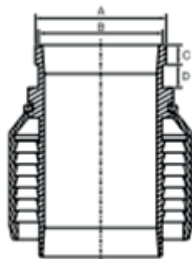

Código do Item	Número da Peça	Mangueira DI in	Mangueira DI mm	Cabeça DN in	Cabeça A mm	Cabeça B mm	Cabeça C mm	Cabeça D mm	Material
2306772	IV39VL00-051060	2	51	2	60,3	57,2	16	20	Aço Temperado
2301752	IV39VL00-051089	2	51	3	88,9	84,9	16	20	Aço Temperado
2301753	IV39VL00-063089	2 1/2	63	3	88,9	84,9	16	20	Aço Temperado
2301754	IV39VL00-076089	3	76	3	88,9	84,9	16	20	Aço Temperado
2302892	IV39VL00-076097	3	76	3 1/4	97	88,5	16	20	Aço Temperado
2302217	IV39VL00-102114	4	102	4	114,3	108,3	17	20	Aço Temperado
2302216	IV39VL00-102127	4	102	4 1/2	127	115	17	20	Aço Temperado
2302219	IV39VL00-127142	5	127	5	142	133	17	20	Aço Temperado
2302220	IV39VL00-127148	5	127	5 1/2	148	139	17	20	Aço Temperado
2302893	IV39VL00-152168	6	152	6	168,3	159	17	20	Aço Temperado

ACOPLAMENTO PARA CONCRETO COMPLETA COM PONTEIRA PRÉ-CRIMPADA

Estilo suportado - Inserção endurecida

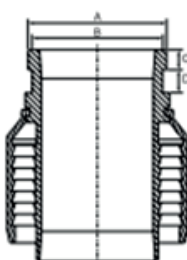

Código do Item	Número da Peça	Mangueira DI in	Mangueira DI mm	Cabeça DN in	Cabeça A mm	Cabeça B mm	Cabeça C mm	Cabeça D mm	Material
2303021	IV39RL00-051067	2	51	2	66,5	59,5	16	20	Aço Temperado
2303022	IV39RL00-063097	2 1/2	63	3	97	88,5	16	20	Aço Temperado
2303023	IV39RL00-076097	3	76	3	97	88,5	16	20	Aço Temperado
2303024	IV39RL00-090122	3 1/2	90	4	122	115	17,5	20	Aço Temperado
2306505	IV39RL00-090127	3 1/2	90	4 1/2	127	115	17	20	Aço Temperado
2303025	IV39RL00-102122	4	102	4	122	115	17,5	20	Aço Temperado



CATÁLOGO DE PRODUTOS

Acoplamento para mangueiras de concreto com ponteiros pré-crimpadas (disponibilidade sob consulta):

ACOPLAMENTO PARA CONCRETO COMPLETA COM PONTEIRA PRÉ-CRIMPADA

Estilo Schwing - Macho - Inserção endurecida

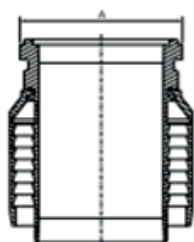

Código do Item	Número da Peça	Mangueira DI in	Mangueira DI mm	Cabeça DN in	Cabeça A mm	Material
2302896	IV39WM00-102102	4	102	4	148	Aço Temperado
2302897	IV39WM00-127127	5	127	5	166	Aço Temperado
2306525	IV39WM00-152152	6	152	6	195	Aço Temperado

Peças adequadas para aço endurecido

	Accessórios rosca fêmea/macho	Victaulic	Suportado	California	Estilo Schwing
737AA	X		X		
740AA	X	X	X	X	X
741AA	X	X	X	X	X



CATÁLOGO DE PRODUTOS

Adaptadores e conexões (disponibilidade sob consulta):





LINHAS PNEUMÁTICAS



CATÁLOGO DE PRODUTOS

Tubos flexíveis (Poliuretano PU):



D. E. mm	D. I. mm	Espessura da parede mm	Pressão de trabalho bar @ 20°C	Pressão mínima de ruptura bar @ 20°C	Raio mínimo de curvatura mm	Peso por 100 metros kg
4	2,5	0,75	10	30	17	0,90
6	4	1,00	10	30	27	1,80
8	5,5	1,25	10	30	37	3,40
10	7	1,50	10	30	54	5,10
12	8	2,00	10	30	62	7,30

União dupla Tubo / tubo:

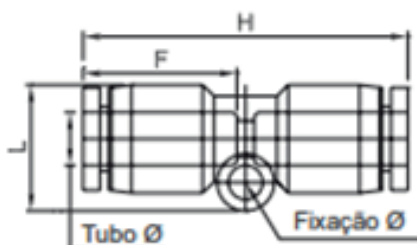

Ø tubo	H	L	Ø fixação	Profundidade do tubo (F)
4	34,6	12,75	3,3	16,8
6	36,8	14,75	3,3	17,6
8	39,4	19,85	4,3	18,7
10	43,2	20,00	4,3	19,6
12	47,8	23,30	4,3	21,9



CATÁLOGO DE PRODUTOS

União dupla redução Tubo / tubo:

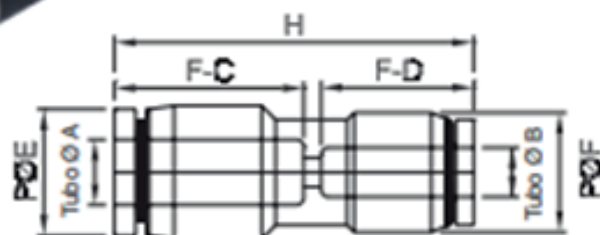

Ø tubo		H	F-C	F-D	P Ø E	P Ø F
A	B					
6	4	36,6	17,6	16,8	12,5	10,5
8	6	37,6	18,7	17,6	14,5	12,5
10	8	41,0	19,6	18,7	17,5	14,5
12	10	44,0	21,9	19,6	20,5	17,5

União dupla painel Tubo / tubo:

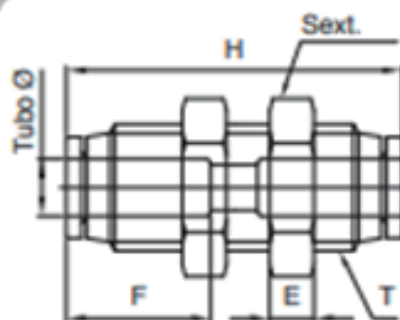

Ø tubo	H	T	E	Profundidade do tubo (F)	Sextavado
4	35,5	M12 x 1	4	16,3	14
6	39,9	M14 x 1	4	17,6	17
8	42,2	M16 x 1	5	18,7	19
10	45,0	M20 x 1	5	19,6	24
12	50,3	M22 x 1	5	21,9	26



CATÁLOGO DE PRODUTOS

Redutor:

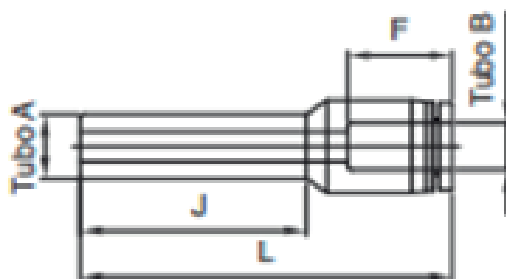

Ø tubo		J	L	Profundidade do tubo (F)
A	B			
6	4	21,7	41,0	16,3
8	4	22,7	42,0	16,3
8	6	23,7	44,3	17,6
10	6	28,7	47,3	17,6
12	6	33,8	50,2	17,6
10	8	27,7	49,7	18,7
12	8	30,7	52,5	18,7
12	10	31,2	56,5	19,6

Plug:



Ø tubo	J	L	Profundidade do tubo (F)
4	17,7	30	4
6	19,4	34	6
8	21,2	38	8
10	23,8	42	10
12	29,5	46	12



CATÁLOGO DE PRODUTOS

União macho Rosca BSPT / M5:

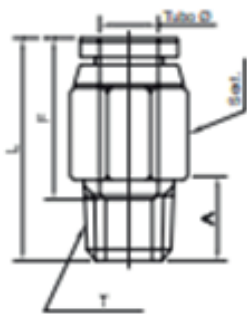

Ø tubo	T BSPT	L	A	Profundidade do tubo (F)	Sextavado
4	M5 x 0,8	21,9	4,6	15,9	10
	1/8-28	21,6	8,0	15,9	10
	1/4-19	20,6	10,0	15,9	14
6	M5 x 0,8	23,6	4,6	16,5	10
	1/8-28	22,2	8,0	16,5	12
	1/4-19	21,0	10,0	16,5	14
	3/8-19	22,0	11,0	16,5	17
	1/2-14	22,0	14,0	16,5	22
8	1/8-28	27,5	8,0	17,7	12
	1/4-19	25,5	10,0	17,7	14
	3/8-19	23,0	11,0	17,7	17
	1/2-14	29,7	14,0	17,7	22
10	1/8-28	28,7	8,0	18,6	12
	1/4-19	30,7	10,0	18,6	14
	3/8-19	24,7	11,0	18,6	17
	1/2-14	29,7	14,0	18,6	22
12	1/4-19	32,8	10,0	20,9	14
	3/8-19	29,8	11,0	20,9	17
	1/2-14	29,8	14,0	20,9	22

União macho Rosca BSPT / M5:

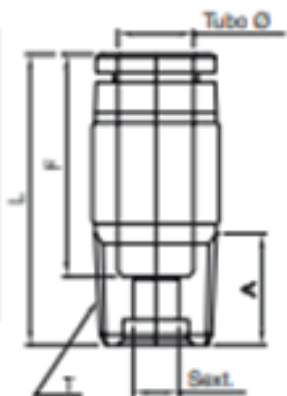

Ø tubo	T BSPT	L	A	Profundidade do tubo (F)	Sextavado interno
4	M5 x 0,8	21,8	4,6	15,9	2
	1/8-28	20,4	8,0	15,9	3
	1/4-19	20,4	10,0	15,9	3
6	M5 x 0,8	22,6	4,6	16,5	2
	1/8-28	21,8	8,0	16,5	4
	1/4-19	22,5	10,0	16,5	4
	3/8-19	22,5	11,0	16,5	4
8	1/8-28	27,0	8,0	17,7	6
	1/4-19	25,0	10,0	17,7	6
	3/8-19	25,0	11,0	17,7	6
	1/2-14	25,0	14,0	17,7	5
10	1/8-28	27,0	8,0	18,6	6
	1/4-19	26,6	10,0	18,6	6
	3/8-19	26,6	11,0	18,6	6
	1/2-14	26,6	14,0	18,6	6
12	1/4-19	32,4	10,0	20,9	6
	3/8-19	32,4	11,0	20,9	8
	1/2-14	32,4	14,0	20,9	8



CATÁLOGO DE PRODUTOS

União fêmea Rosca BSPP:

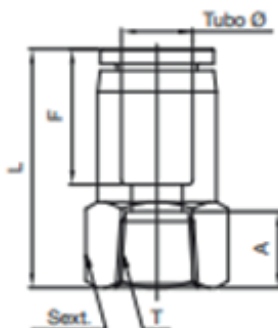

Ø tubo	T BSPP	L	A	Profundidade do tubo (F)	Sextavado
4	1/8-28	28,6	8,0	15,9	14
	1/4-19	29,6	10,0	15,9	17
6	1/8-28	30,0	8,0	16,5	14
	1/4-19	31,0	10,0	16,5	17
	3/8-19	32,0	11,0	16,5	22
8	1/8-28	31,0	8,0	17,7	14
	1/4-19	32,0	10,0	17,7	17
10	1/4-19	32,7	10,0	18,6	17
	3/8-19	33,7	11,0	18,6	22
	1/2-14	35,7	14,0	18,6	24
12	1/4-19	36,4	10,0	20,9	22
	3/8-19	36,4	11,0	20,9	22
	1/2-14	38,4	14,0	20,9	24

União fêmea painel Rosca BSPP:

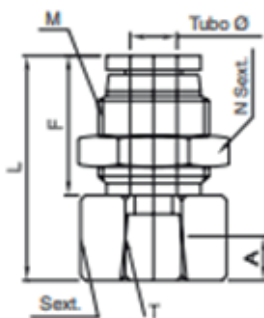

Ø tubo	T BSPP	L	M	A	Sextavado N	Prof. do tubo (F)	Sextavado
4	1/8-28	26,7	M12 x 1	9	14	16,8	14
	1/8-28	28,3	M14 x 1	9	17	17,6	17
6	1/4-19	30,3	M14 x 1	11	17	17,6	17
	3/8-19	32,3	M14 x 1	12	17	17,6	17
8	1/8-28	29,5	M16 x 1	9	19	18,7	19
	1/4-19	31,5	M16 x 1	11	19	18,7	19
	3/8-19	32,5	M16 x 1	12	19	18,7	22
10	1/4-19	32,4	M20 x 1	11	24	19,6	24
	3/8-19	33,4	M20 x 1	12	24	19,6	24
	1/2-14	35,4	M20 x 1	14	24	19,6	24
12	3/8-19	37,9	M22 x 1	12	26	21,9	24
	1/2-14	39,9	M22 x 1	14	26	21,9	24



CATÁLOGO DE PRODUTOS

Cotovelo união Tubo / tubo:

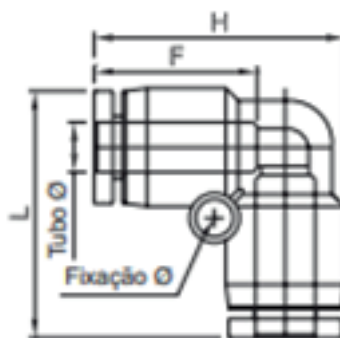

Ø tubo	H	L	Ø fixação	Profundidade do tubo (F)
4	36,6	24,20	3,3	16,8
6	41,8	27,50	3,3	17,6
8	44,9	30,65	4,3	18,7
10	48,2	34,05	4,3	19,6
12	56,8	39,85	4,3	21,9

Cotovelo união painel Tubo / tubo:

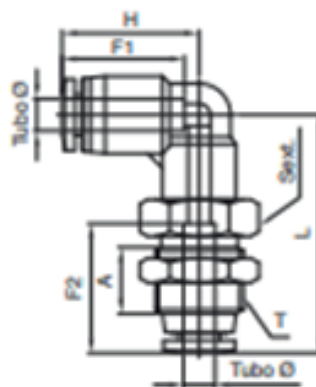

Ø tubo	T	H	L	Profundidade do tubo		Sextavado
				F1	F2	
4	M12 x 1	18,7	32,4	16,3	16,3	14
6	M14 x 1	20,4	38,2	17,5	17,0	17
8	M16 x 1	23,1	40,3	19,1	18,6	19
10	M20 x 1	23,7	42,3	19,7	20,3	24
12	M22 x 1	27,7	48,1	22,2	23,4	26



CATÁLOGO DE PRODUTOS

Cotovelo tubo:

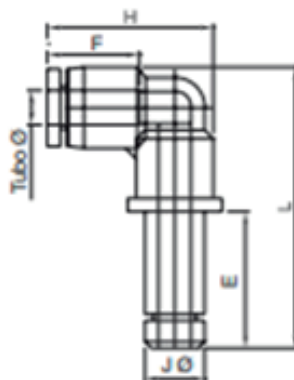

Ø tubo	E	Ø J	L	H	Profundidade do tubo (F)
4	20,5	4	39,2	23,8	16,8
6	23,0	6	44,7	26,5	17,6
8	26,5	8	50,6	28,4	18,7
10	29,0	10	55,2	32,1	19,6
12	33,3	12	63,9	36,9	21,9

Cotovelo macho orientável Rosca BSPT / M5:

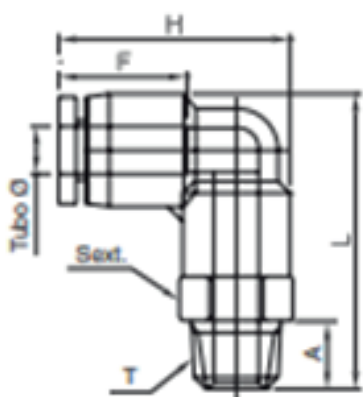

Ø tubo	T BSPT	L	H	A	Profundidade do tubo (F)	Sextavado
4	M5 x 0.8	27,25	23,8	4,6	4,6	10
	1/8-28	29,75	23,8	16,8	8,0	10
	1/4-19	31,75	23,8	10,0	10,0	14
6	M5 x 0.8	30,25	26,5	4,6	4,6	10
	1/8-28	32,75	26,5	16,8	8,0	12
	1/4-19	35,75	26,5	10,0	10,0	14
8	3/8-19	36,75	26,5	11,0	11,0	17
	1/8-28	35,15	29,7	16,8	8,0	12
	1/4-19	38,15	29,7	10,0	10,0	14
	3/8-19	39,15	29,7	11,0	11,0	17
10	1/2-14	42,15	29,7	14,0	14,0	22
	1/8-28	37,25	32,1	16,8	8,0	12
	1/4-19	40,25	32,1	10,0	10,0	14
12	3/8-19	41,25	32,1	11,0	11,0	17
	1/2-14	44,25	32,1	14,0	14,0	22
	1/4-19	44,65	36,9	10,0	10,0	14
	3/8-19	45,65	36,9	11,0	11,0	17
	1/2-14	48,65	36,9	14,0	14,0	22



CATÁLOGO DE PRODUTOS

Cotovelo macho orientável longo Rosca BSPT /

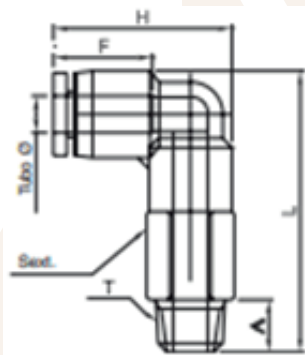

Ø tubo	T BSPT	L	H	A	Profundidade do tubo (F)	Sextavado
4	M5 x 0.8	38,75	23,8	4,6	16,8	10
	1/8-28	40,75	23,8	8,0	16,8	10
	1/4-19	42,75	23,8	10,0	16,8	14
	3/8-19	43,75	23,8	11,0	16,8	17
6	M5 x 0.8	44,5	26,5	4,6	17,6	10
	1/8-28	46,25	26,5	8,0	17,6	12
	1/4-19	48,25	26,5	10,0	17,6	14
	3/8-19	49,25	26,5	11,0	17,6	17
8	1/8-28	51,15	29,7	8,0	18,7	12
	1/4-19	53,15	29,7	10,0	18,7	14
	3/8-19	54,15	29,7	11,0	18,7	17
	1/2-14	57,15	29,7	14,0	18,7	22
10	1/8-28	48,45	32,1	8,0	19,6	12
	1/4-19	50,45	32,1	10,0	19,6	14
	3/8-19	51,45	32,1	11,0	19,6	17
	1/2-14	54,45	32,1	14,0	19,6	22
12	1/4-19	66,15	36,9	10,0	21,9	14
	3/8-19	67,15	36,9	11,0	21,9	17
	1/2-14	70,15	36,9	14,0	21,9	22

Banjo simples Rosca BSPT / M5:

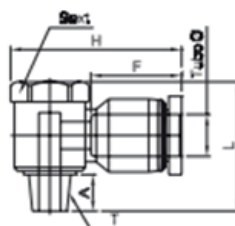

Ø tubo	T BSPT	L	H	A	Sextavado
4	M5 x 0.8	22,1	26,6	4,6	8
	1/8-28	32,4	31,5	8,0	14
6	M5 x 0.8	22,1	27,2	4,6	8
	1/8-28	32,4	32,4	8,0	14
8	1/4-19	35,3	35,6	10,0	17
	1/8-28	32,4	39,2	8,0	14
	1/4-19	35,3	37,7	10,0	17
10	3/8-19	39,7	42,7	11,0	21
	1/4-19	35,3	42,5	10,0	17
	3/8-19	39,7	43,6	11,0	21
12	1/2-14	47,8	45,6	14,0	24
	3/8-19	39,7	45,9	11,0	21
	1/2-14	47,8	48,3	14,0	24



CATÁLOGO DE PRODUTOS

Tê união Tubo / tubo / tubo:

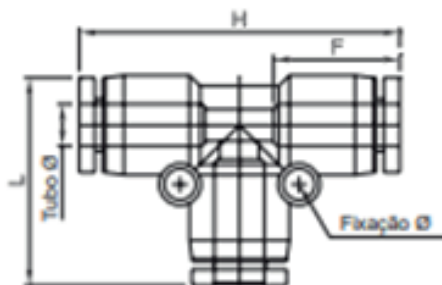

Ø tubo	H	L	Ø fixação	Profundidade do tubo (F)
4	36,6	24,20	3,3	16,8
6	41,8	27,50	3,3	17,6
8	44,9	30,65	4,3	18,7
10	48,2	34,05	4,3	19,6
12	56,8	39,85	4,3	21,9

Tê macho central orientável Rosca BSPT / M5:

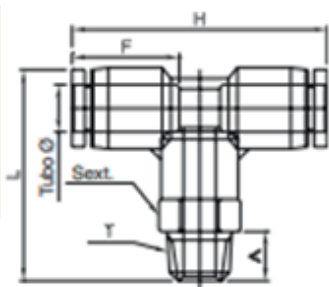

Ø tubo	T BSPT	L	H	A	Profundidade do tubo (F)	Sextavado
4	M5 x 0,8	27,25	37,6	4,6	16,8	10
	1/8-28	29,75	37,6	8,0	16,8	10
	1/4-19	31,75	37,6	10,0	16,8	14
6	M5 x 0,8	30,25	41,0	4,6	17,6	10
	1/8-28	32,75	41,0	8,0	17,6	12
	1/4-19	35,75	41,0	10,0	17,6	14
8	3/8-19	36,75	41,0	11,0	17,6	17
	1/8-28	35,25	44,4	8,0	18,7	12
	1/4-19	38,25	44,4	10,0	18,7	14
10	3/8-19	39,25	44,4	11,0	18,7	17
	1/2-14	42,25	44,4	14,0	18,7	22
	1/8-28	37,25	47,2	8,0	19,6	12
12	1/4-19	40,25	47,2	10,0	19,6	14
	3/8-19	41,25	47,2	11,0	19,6	17
	1/2-14	44,25	47,2	14,0	19,6	22
12	1/4-19	44,65	54,8	10,0	21,9	14
	3/8-19	45,65	54,8	11,0	21,9	17
	1/2-14	48,65	54,8	14,0	21,9	22



CATÁLOGO DE PRODUTOS

Tê macho lateral orientável Rosca BSPT / M5:

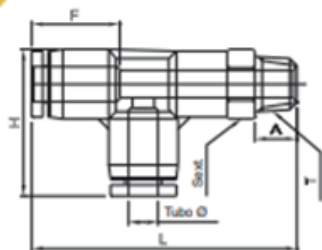

Ø tubo	T BSPT	L	H	A	Profundidade do tubo (F)	Sextavado
4	M5 x 0.3	42,3	25,1	4,6	16,8	10
	1/8-28	45,3	25,1	8,0	16,8	10
	1/4-19	48,3	25,1	10,0	16,8	14
6	M5 x 0.8	46,1	28,1	4,6	17,6	10
	1/8-28	48,6	28,1	8,0	17,6	12
	1/4-19	51,2	28,1	10,0	17,6	14
8	3/8-19	52,2	28,1	11,0	17,6	17
	1/8-28	52,2	30,9	8,0	18,7	12
	1/4-19	55,2	30,9	10,0	18,7	14
10	3/8-19	56,2	30,9	11,0	18,7	17
	1/2-14	59,2	30,9	14,0	18,7	22
	1/8-28	55,6	34,6	8,0	19,6	12
12	1/4-19	58,6	34,6	10,0	19,6	14
	3/8-19	59,6	34,6	11,0	19,6	17
	1/2-14	62,6	34,6	14,0	19,6	22
12	1/4-19	64,8	40,3	10,0	21,9	14
	3/8-19	65,8	40,3	11,0	21,9	17
	1/2-14	68,8	40,3	14,0	21,9	22

Conector Y união Tubo / tubo / tubo:

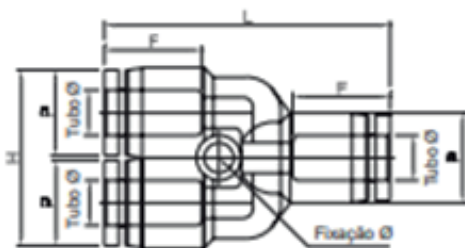

Ø tubo	H	L	F	Ø P	Ø fixação
4	21	37,1	16,8	10,5	3,3
6	25	40,2	17,6	12,5	3,3
8	29	43,4	18,7	14,5	4,3
10	35	47,7	19,6	17,5	4,3
12	41	53,3	21,9	20,5	4,3



CATÁLOGO DE PRODUTOS

Conector Y união redução Tubo / tubo / tubo:

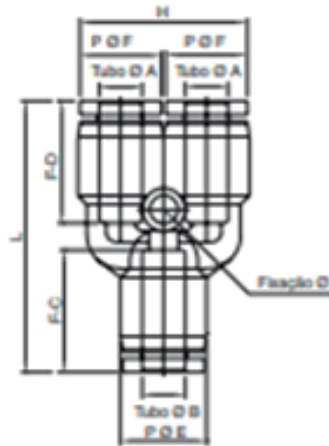

Ø tubo		L	H	F-C	F-D	P OE	P OF	Ø fixação
A	B							
4	6	37,9	21	17,6	16,8	12,5	10,5	3,3
6	8	41,3	25	18,7	17,6	14,5	12,5	4,3
8	10	43,3	29	19,6	18,7	17,5	14,5	4,3
10	12	46,5	35	21,9	19,6	20,5	17,5	4,3

Conector Y união tubo redução:

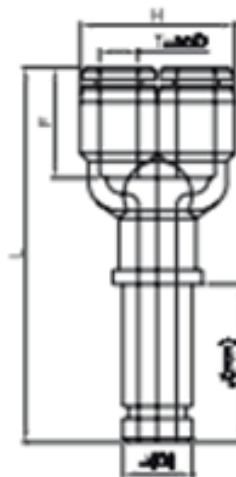

Ø tubo		J	Ø J	L	H	Profundidade do tubo (F)
A	B					
6	4	23,0	6	56,2	21	17,6
8	6	26,5	8	61,0	25	18,7
10	8	29,0	10	69,1	29	19,6
12	10	33,3	12	76,7	35	21,9



CATÁLOGO DE PRODUTOS

Cruzeta união Tubo / tubo:

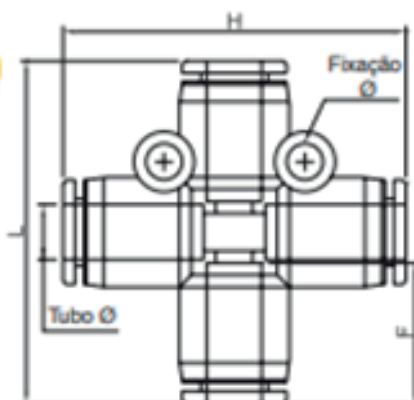

Ø tubo	H	L	F	Ø Fixação
4	36,6	37,9	16,8	3,3
6	41,8	42,5	17,6	3,3
8	44,9	46,8	18,7	4,3
10	48,2	50,5	19,6	4,3
12	54,8	57,2	21,9	4,3

- Válvulas controladoras de fluxo (lineares e angulares):

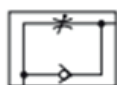

CATÁLOGO DE PRODUTOS

- Linear Tubo / tubo:

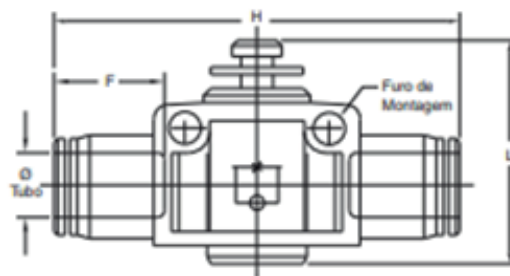

Ø tubo	L		Ø furo de montagem	H	Profundidade do tubo (F)
	Mínimo	Máximo			
4	29.9	33.3	3.3	45.1	16.8
6	35	39.5	4.3	50.3	17.6
8	37.4	42.1	4.4	55.7	18.7
10	43.8	49	4.4	61.2	19.6
12	467.4	53.6	4.4	69.8	21.9

- Angular orientável Tubo / macho BSPT Tubo / macho métrica:

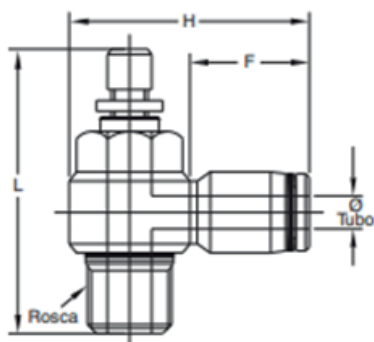

Ø tubo	L		Rosca BSPT	H	F	A	Sext.
	mínimo	máximo					
4	33.7	37	M5 x 0.8P	26.6	16.8	4.6	08
	44.3	48.6	PT 1/8	31.5	16.8	8	14
	44.3	48.6	PT 1/4	34.8	16.8	10	17
6	33.7	37	M5 x 0.8P	27.2	17.6	4.6	08
	44.3	48.6	PT 1/8	32.4	17.6	8	14
	44.3	48.6	PT 1/4	35.6	17.6	10	17
8	47.6	52	PT 3/8	40.9	17.6	11	21
	44.3	48.6	PT 1/8	39.2	18.7	8	14
	44.3	48.6	PT 1/4	37.7	18.7	10	17
10	52	57.5	PT 3/8	42.7	18.7	11	21
	47.6	52	PT 1/4	37.9	19.6	10	17
	52	57.5	PT 3/8	43.6	19.6	11	21
12	61.3	67.2	PT 1/2	45.6	19.6	14	24
	47.6	52	PT 1/4	39.2	21.9	10	17
	52	57.5	PT 3/8	45.9	21.9	11	21
	61.3	67.2	PT 1/2	48.3	21.9	14	24





MACCHINA PRO

LINHAS HIDRÁULICAS

entre em contato conosco!

